

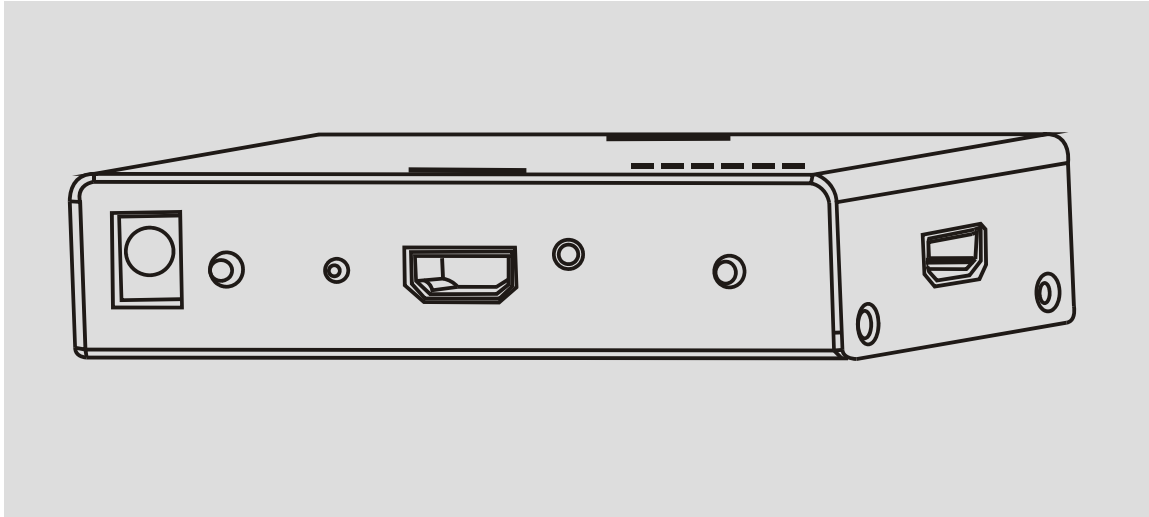

HDMI Switching Matrix

Model No. MX0402-001

Operating Instructions (P/N of this Instructions is INSMX0402-001)



FEATURES

- Compact size, could be installed in hidden place.
- Mounting gears supplied for easy installation.
- Easy to use: install in seconds, no need for setting.
- Two outputs show different sources simultaneously.
- Distribute any of the four inputs to any of the two outputs.
- Triple switching modes, auto, IR remote and manual.
- With extra infrared receiver extension.
- Each port supports HDMI or DVI inputs.
- Signaling rates up to 2.25Gbps in support of 1080P display.
- HDMI V1.3
- HDCP compliant.

Dear customer:

Thank you for purchasing this product. For optimum performance and safety, please read these instructions carefully before connecting, operating or adjusting this product. Please keep this manual for future reference.

NOTICE

Grandbeing Inc. reserves the right to make changes in the hardware, packaging and any accompanying documentation without prior written notice.



WARNING:

TO REDUCE THE RISK OF FIRE, ELECTRIC SHOCK OR PRODUCT DAMAGE:

- 1) DO NOT EXPOSE THIS APPARATUS TO RAIN, MOISTURE, DRIPPING OR SPLASHING AND THAT NO OBJECTS FILLED WITH LIQUIDS, SUCH AS VASES, SHALL BE PLACED ON THE APPARATUS.
- 2) DO NOT INSTALL OR PLACE THIS UNIT IN A BOOKCASE, BUILT-IN CABINET OR IN ANOTHER CONFINED SPACE. ENSURE THE UNIT IS WELL VENTILATED.
- 3) TO PREVENT RISK OF ELECTRIC SHOCK OR FIRE HAZARD DUE TO OVERHEATING, DO NOT OBSTRUCT THE UNIT'S VENTILATION OPENINGS WITH NEWSPAPERS, TABLECLOTHS, CURTAINS, AND SIMILAR ITEMS.
- 4) DO NOT INSTALL NEAR ANY HEAT SOURCES SUCH AS RADIATORS, HEAT REGISTERS, STOVES, OR OTHER APPARATUS (INCLUDING AMPLIFIERS) THAT PRODUCE HEAT.
- 5) DO NOT PLACE SOURCES OF NAKED FLAMES, SUCH AS LIGHTED CANDLES, ON THE UNIT.
- 6) CLEAN THIS APPARATUS ONLY WITH DRY CLOTH.
- 7) UNPLUG THIS APPARATUS DURING LIGHTNING STORMS OR WHEN UNUSED FOR LONG PERIODS OF TIME.
- 8) PROTECT THE POWER CORD FROM BEING WALKED ON OR PINCHED PARTICULARLY AT PLUGS.
- 9) ONLY USE ATTACHMENTS/ACCESSORIES SPECIFIED BY THE MANUFACTURER.
- 10) REFER ALL SERVICING TO QUALIFIED SERVICE PERSONNEL.

TABLE OF CONTENTS

Introduction	4
Package Contents.....	4
Panel Descriptions	4
Connect and Operation.....	6
Specification.....	9
Typical Application	9
Maintenance	10
Product Service.....	10
Warranty	10
Contact Information.....	1 0

INTRODUCTION

Grandbeing's MX0402-001 is a 4-by-2 DVI/HDMI switching matrix. It allows up to 4 digital DVI or HDMI ports to be switched to two independent displays. The two outputs can display different sources from different inputs simultaneously.

MX0402-001 has the ability of equalization and amplification to ensure HDMI signal's transmission through long cable without quality loss.

MX0402 -001 offers solutions for digital entertainment center, HDTV retail and show site, HDTV, STB, DVD and projector factory, noise, space and security concerns, data center control, information distribution, conference room presentation, school and corporate training environments.

PACKAGE CONTENTS

1. Main unit. P/N_MX0402-001.
2. DC Power Supply, 5V /1A.
3. Remote.
4. IR extension cable.
5. Mounting gears.
6. Operating Instructions. P/N_INS MX0402-001.

*PART NUMBER (Abbreviation as P/N).

PANEL DESCRIPTIONS

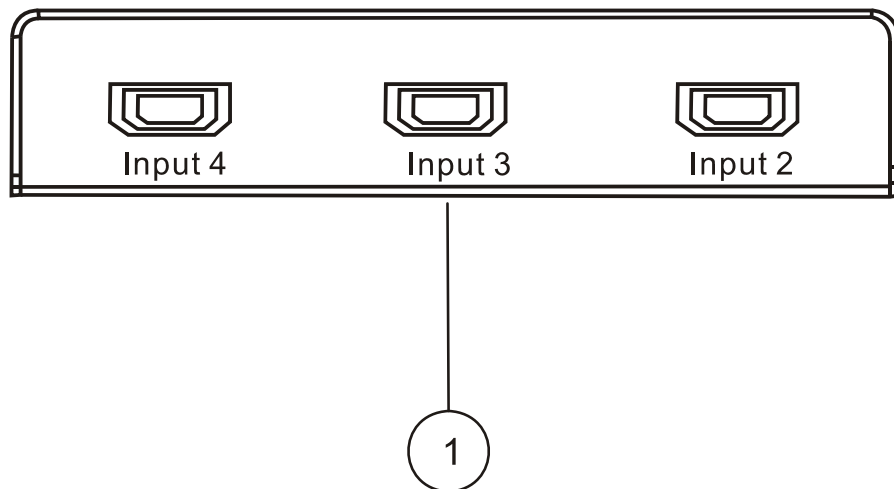

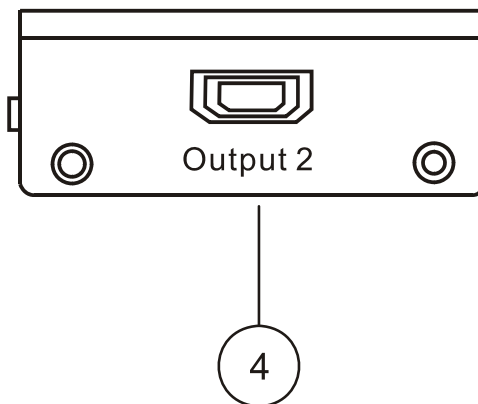
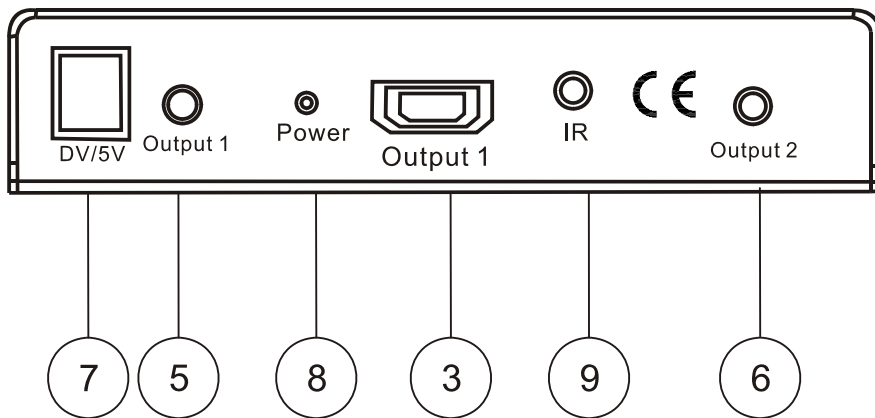
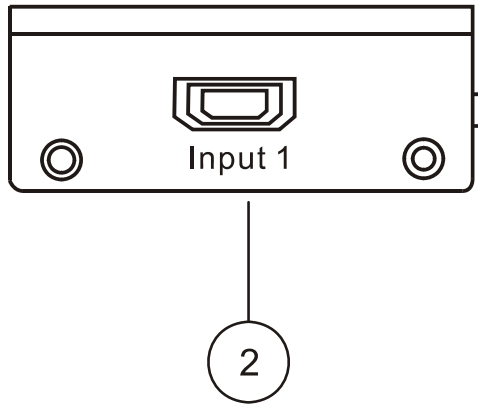

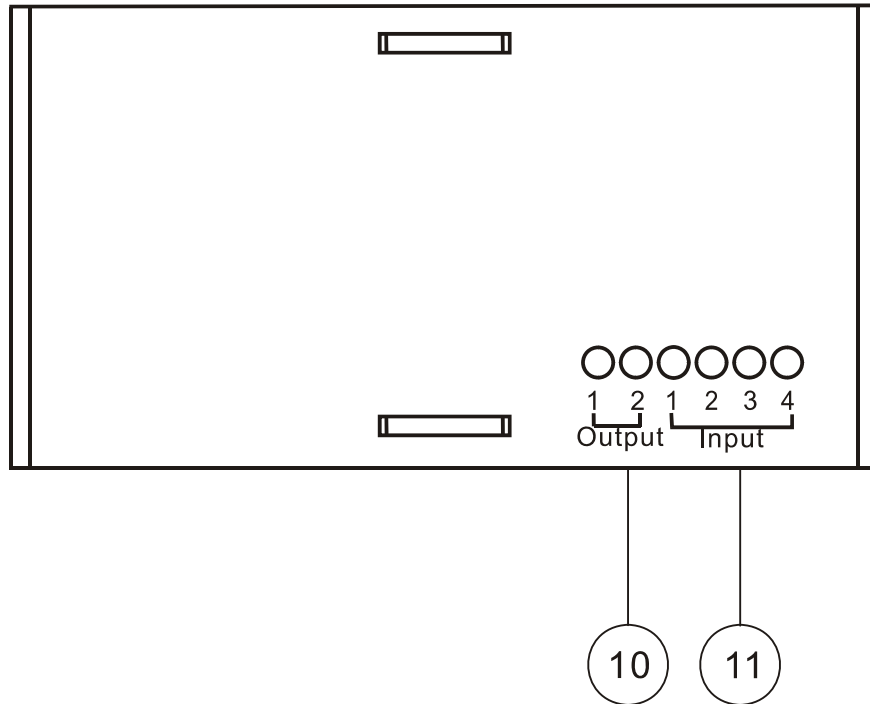

- | | |
|---|---|
| <ol style="list-style-type: none"> 1) HDMI input ports 2 to 4. 2) HDMI input port 1. 3) HDMI output port 1. 4) HDMI output port 2. 5) Output 1selection. Choosing input for output port1 by pushing this button. | <ol style="list-style-type: none"> 6) Output 2 selection. Choosing input for output port 2 by pushing this button. 7) Power input. 8) Power indicator. 9) IR window. 10) Output indicators. 11) Input indicators. |
|---|---|

CONNECT AND OPERATION

- 1) Connect the HDMI input sources (such as HD-DVD, PS3, STB etc) into MX0402-001.
- 2) Connect the HDMI outputs (such as HD-LCD, HD-DLP) into MX0402-001.
- 3) Power on the input source you want to show. (Keep the unused input power off,otherwise it may interfere the normal display.)
- 4) Power on the display you want to watch.
- 5) Use remote or push the button to choose input source. Only when the source is non-HDCP, it is shown on both displays. Otherwise the two displays always show different images.



Insert / Extract cables gently.

When the power is on , all the LEDs flash once.

1.LED indicator

● **Output indicator:**

When a HDMI equipment is connected, the corresponding LED lights on. LED is red when Output 1 works, blue when Output 2 works.

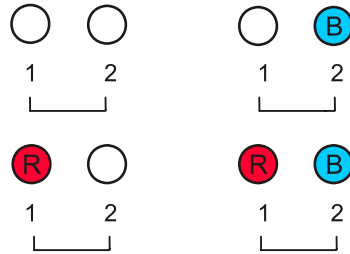

Output indicator

● **Input indicator:**

There are four input LED indicators for corresponding input ports. Each LED has three color states:

- a. Red: the corresponding input is selected by Output 1;
- b. Blue: the corresponding input is selected by Output 2;
- c. Violet: the corresponding input is selected by both Output 1 and Output 2.

(*When the input signal is DVI or HDMI without HDCP, the Output 1 and Output 2 display the same input simultaneously. while the input signal is DVI or HDMI with HDCP, only the output port that selects the input first or the output that is latest connected has the priority to display.)

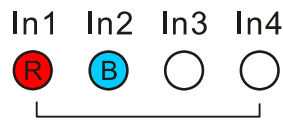

Output 1 chooses In1, Output 2 chooses In2

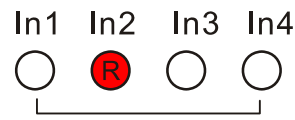

Output 1 chooses In2

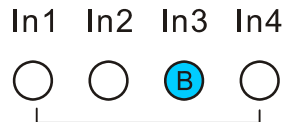

Output 2 chooses In3

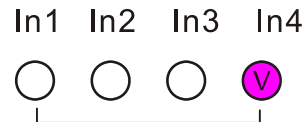

Output 1 chooses In4, Output 2 chooses In4

When the HDMI signal is in, the corresponding LED will flash, showing that the input source has been connected.

2.Manual button control on panel

Output 1 button controls Output 1, Output 2 button controls Output 2.

Manual button control is used when there are more than one input sources, when there is only one input source, the two output ports will both switch to this input. MCU can detect the current state of the input source .While pushing the button to select the inputs, if the current input port has no signals, this port will be skipped and only the active inputs could be selected.

3.Remote control

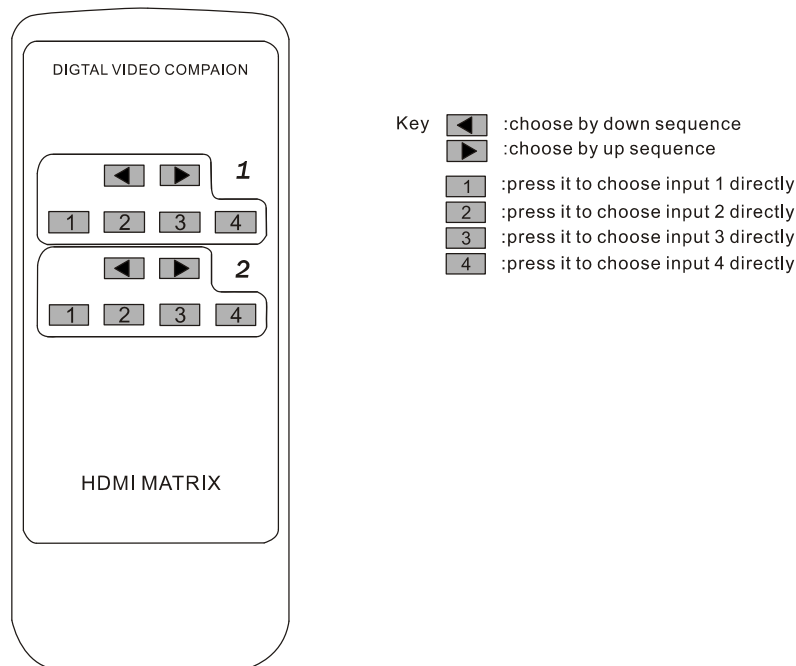

4.Remote locking function

When remote is locked, remote control will be non-functional.

Lock and unlock methods:

If and only if input 1 has signal, press button 2 for two seconds , then input port 4 LED lights on, and then press button 2 for five times (within two seconds). When the input port 3 LED lights on, again press the button for two seconds and finally the input port 2 LED will flash twice(red for locking, blue for unlocking).

Lock and unlock have the same operation.

SPECIFICATIONS

Operating temperature range	-5 to +35°C(-41 to +95 °F)
Operating humidity range	5 to 90 % RH (no condensation)
Input video signal	0.5-1.0 volts p-p
Input DDC Signal	5 volts p-p (TTL)
Signaling rate	2.25Gbit/s
Video format supported	DTV/HDTV:1080P/1080i/720P/576P/480P/576i/480i
Output video	HDMI1.3
Maximum transmission distance	<15m(If needed, HDMI extender is optional)
Power Consumption	1.5wtts(Max)
Dimensions	60mmW×115mmH×25mmD/2.45"W×4.7"H×1"D
Mass(Main unit)	0.2kg/0.45lb

***Note: Specifications are subject to change without notice. Mass and dimensions are approximate.**

TYPICAL APPLICATION

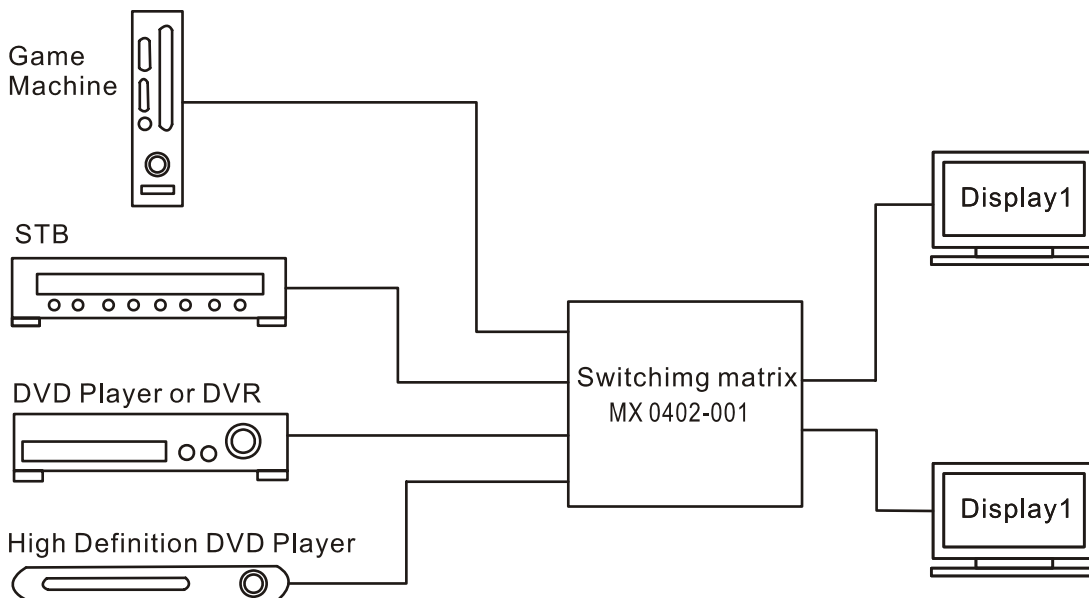

MAINTENANCE

Clean this unit with a soft, dry cloth. Never use alcohol, paint thinner or benzine to clean this unit.

PRODUCT SERVICE

- 1) **Damage requiring service:** The unit should be serviced by qualified service personnel if:
 - (a) The DC power supply cord or AC adaptor has been damaged;
 - (b) Objects or liquids have gotten into the unit;
 - (c) The unit has been exposed to rain;
 - (d) The unit does not operate normally or exhibits a marked change in performance;
 - (e) The unit has been dropped or the cabinet has been damaged.
- 2) **Servicing Personnel:** Do not attempt to service the unit beyond that described in these operating instructions. Refer all other servicing to authorized servicing personnel.
- 3) **Replacement parts:** When parts need replacing ensure the servicer uses parts specified by the manufacturer or parts that have the same characteristics as the original parts. Unauthorized substitutes may result in fire, electric shock, or other hazards.
- 4) **Safety check:** After repairs or service, ask the servicer to perform safety checks to confirm that the unit is in proper working condition.

WARRANTY

If your product does not work properly because of a defect in materials or workmanship, Grandbeing Company (referred to as “the warrantor”) will, for the length of the period indicated as below, (**Parts (1) Year, Labor(90) Days**) which starts with the date of original purchase (“Limited Warranty period”), at its option either (a) repair your product with new or refurbished parts, or (b) replace it with a new or a refurbished product. The decision to repair or replace will be made by the warrantor.

During the “Labor” Limited Warranty period there will be no charge for labor. During the “Parts” warranty period, there will be no charge for parts. You must mail-in your product during the warranty period. This Limited Warranty is extended only to the original purchaser and only covers product purchased as new. A purchase receipt or other proof of original purchase date is required for Limited Warranty service.

Mail-In Service

When shipping the unit, carefully pack and send it prepaid, adequately insured and preferably in the original carton. Include a letter detailing the complaint and provide a day time phone and/or email address where you can be reached.

IF REPAIR IS NEEDED DURING THE LIMITED WARRANTY PERIOD THE PURCHASER WILL BE REQUIRED TO FURNISH A SALES RECEIPT/PROOF OF PURCHASE INDICATING DATE OF PURCHASE, AMOUNT PAID AND PLACE OF PURCHASE. CUSTOMER WILL BE CHARGED FOR THE REPAIR OF ANY UNIT RECEIVED WITHOUT SUCH PROOF OF PURCHASE.

LIMITED WARRANTY LIMITS AND EXCLUSIONS

- 1) This Limited Warranty ONLY COVERS failures due to defects in materials or workmanship, and DOES NOT COVER normal wear and tear or cosmetic damage. The Limited Warranty ALSO DOES NOT COVER damages which occurred in shipment, or failures which are caused by products not supplied by the warrantor, or failures which result from accidents, misuse, abuse, neglect, mishandling, misapplication, alteration, faulty installation, set-up adjustments, misadjustment of consumer controls, improper maintenance, power line surge, lightning damage, modification, or service by anyone other than a Factory Servicenter or other Authorized Servicer, or damage that is attributable to acts of God.
- 2) THERE ARE NO EXPRESS WARRANTIES EXCEPT AS LISTED UNDER "LIMITED WARRANTY COVERAGE". THE WARRANTOR IS NOT LIABLE FOR INCIDENTAL OR CONSEQUENTIAL DAMAGES RESULTING FROM THE USE OF THIS PRODUCT, OR ARISING OUT OF ANY BREACH OF THIS WARRANTY. (As examples, this excludes damages for lost time, cost of having someone remove or re-install an installed unit if applicable, travel to and from the servicer, loss of or damage to media or images, data or other recorded content. The items listed are not exclusive, but are for illustration only.)
- 3) PARTS AND SERVICE, WHICH ARE NOT COVERED BY THIS LIMITED WARRANTY, ARE YOUR RESPONSIBILITY.



Thank you for your purchase.

We appreciate your business. Please contact us with your question and comments.

**Grandbeing Technology Co., Ltd
6C, Jialitai Building, No. 6 Yanshan Road,
Nanshan District Shenzhen , P.R. China
Post Code:518067**

**Tel:86-755-26678449
Fax:86-755-26678549**

**Email:sales@grandbeing.com,
lauarthur@163.com**

Website:<http://www.grandbeing.com>