



Operating Instructions

Thanks for purchasing our product.

Please be sure to read this instruction manual carefully before using our product.



Introduction

EX0101-S21/S22 is a HDMI extender while using coax cable as transmission media.

Benefits from using EX0101-S21/S22:

- 1) The length of HDMI cable is fixed and unchangeable after it is produced. Because the HDMI connector can only be soldered or terminated by professional worker in factory, the users can not reduce or increase by themselves. However coax cables are available everywhere and be processed easily by the user or installer.
- 2) By using EX0101-S21/S22, the transmission distance for 1080P reaches 60 meters. For general HDMI cables, cables must be customized when the length over 10 meters.
- 3) EX0101-S21/S22 has the ability of buffering and amplifying. Series connection of EX0101-S21/S22 achieves long distance transmission of HDMI signal. When two pairs or more EX0101-S21/S22 are sacked together, they can be used to create a larger distribution (Daisy chained.)
- 4) The IR system could control the sources from the sinks or control the sinks from sources.

EX0101-S21/S22 offers solutions for digital entertainment center, HDTV retail and show site, HDTV, STB, DVD and Projector factory, noise, space and security concerns, data center control, information distribution, conference room presentation, school and corporate training environments.

Contents

HDMI Extender (By single coax cable)	1
■ Product Overview	1
■ Features	1
■ Package Contents	3
■ Connections and Operations	3
■ Specifications	5
■ Panel Descriptions	6
■ Typical Application	8
■ Maintenance	8
■ Product Service	8
● Provided Service	8
● Mail-In Service	9
● Warranty	9
● Warranty Limits And Exclusions	10

HDMI Extender (By single coax cable)

■ Product Overview (Model Number: EX0101-S21/S22)



■ Features











- Use single coax cable to substitute HDMI cable to achieve long distance transmission.
- Transmission distance reaches up to 60 meters under the video format of 1080P.
- Auto-adjustment of feedback, equalization and amplify, the user does not need to care about the length of the cable.
- HDMI V1.3 supported.
- HDCP compliant.
- Full HD support: 1080p@60Hz.
- With LEDs indicators to show the power status and the signal status.
- With ESD protection inside.
- Mounting ears supplied.
- Transfer Bidirectional Infrared control signal together with the HDMI signal.
- This model could be cascaded.

 Notice

Grandbeing Inc. reserves the right to make changes in the hardware, packaging and any accompanying documentation without prior written notice.

 **Warning**

To reduce the risk of fire, electric shock or product damage:



- | | | | |
|---|--|---|---|
|  | <p>1. Do not expose this apparatus to rain, moisture, dripping or splashing and that no objects filled with liquids, such as vases, shall be placed on the apparatus.</p> |  | <p>6. Clean this apparatus only with dry cloth.</p> |
|  | <p>2. Do not install or place this unit in a bookcase, built-in cabinet or in another confined space. Ensure the unit is well ventilated.</p> |  | <p>7. Unplug this apparatus during lightning storms or when unused for long periods of time.</p> |
|  | <p>3. To prevent risk of electric shock or fire hazard due to overheating, do not obstruct the unit's ventilation openings with newspapers, tablecloths, curtains, and similar items.</p> |  | <p>8. Protect the power cord from being walked on or pinched particularly at plugs.</p> |
|  | <p>4. Do not install near any heat sources such as radiators, heat registers, stoves, or other apparatus (including amplifiers) that produce heat.</p> |  | <p>9. Only use attachments / accessories specified by the manufacturer.</p> |
|  | <p>5. Do not place sources of naked flames, such as lighted candles, on the unit.</p> |  | <p>10. Refer all servicing to qualified service personnel.</p> |

■ Package Contents

- ① Main unit NO.1. P/N_EX0101-S21.
- ② Main unit NO.2. P/N_EX0101-S22.
- ③ Operating instructions. P/N_INSEX0101-S21/S22.
- ④ 2x 5VDC power supply P/N_VDC0502.(One for S21, one for S22)
- ⑤ 2xIR TX unit. (IR emitter cable, One for S21, one for S22)
- ⑥ 2xIR RX unit. (IR receiver cable, One for S21, one for S22)

 **NOTE:** PART NUMBER (Abbreviation as P/N)

■ Connections and Operations

- 1) Connect the HDMI input source ( such as HD-DVD、 PS3、 STB etc.) to EX0101-S21.
- 2) Connect a COAX cable from COAX output of EX0101-H01 to COAX input of EX0101-S22.
- 3) Connect the HDMI sink( such as HD-LCD、 HD-DLP) to EX0101-S22.
- 4) Connect the IR TX UNIT into EX0101-S21 IR TX; Connect the IR RX UNIT into EX0101-S22 IR RX.
- 5) Connect the IR RX UNIT into EX0101-S21 IR RX; Connect the IR TX UNIT into EX0101S21 IR TX.

 **Attention:** Please insert and extract cables gently.

※DIP switch setting instruction:

EX0101-S21

Position1	Position2	Position3	Function
0	0	0	1080P stereo (Using Embedded EDID) (note1)
0	0	1	1080P 7.1 (Using Embedded EDID) (note2)
0	1	0	copy the sink's edid to the input port (note3)

Note1: The S21 will use the embedded 1080P-stereo EDID when the DIP switch is in this mode. The EDID will be 1080P video and stereo audio.

Note2: The S21 will use the embedded 1080P-7.1 EDID when the DIP switch is in this mode. The EDID will be 1080P video and 7.1 audio.

Note3: Copy the EDID data to the input port. S21 will copy the EDID data from the sink which connected to the S22.

EX0101-S22

Position1	Position2	Position3	Function
0	0	0	Normal mode
0	0	1	LC mode(note1)

Note1: if video appears noise or interference when the long HDMI cable is used or the quality of HDMI cable is not so good, use this mode.

■ Specifications

Operating Temperature Range	-5 to +35°C (-41 to +95 °F)
Operating Humidity Range	5 to 90 % RH (no condensation)
Input Video Signal	0.5-1.0 volts p-p
Input DDC Signal	5 volts p-p (TTL)
Video Format Supported	DTV/HDTV;1080P/1080i/576i/480i
Output Video	HDMI 1.3+HDCP (repeat the source to the sink)
Output Audio	Support 7.1/5.1/stereo audio
Maximum Transmission Distance	60 meters
Power Supply	5VDC
Power Consumption	5Watts (EX0101-S21) 5Watts (EX0101-S22)
Dimensions	120mmH×115mmW×31mmD /5.98"W×4.13"H×1.22"D
Mass (Main unit)	0.9Kg / 1.98lb (Pairs)

 **NOTE1:** Specifications are subject to change without notice. Mass and dimensions are approximate.

■ Panel Descriptions

1. EX0101-S21

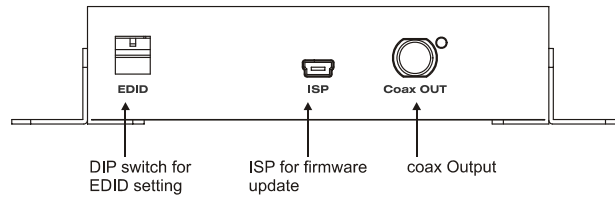
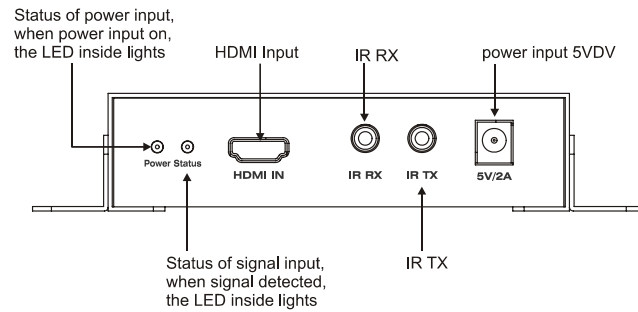
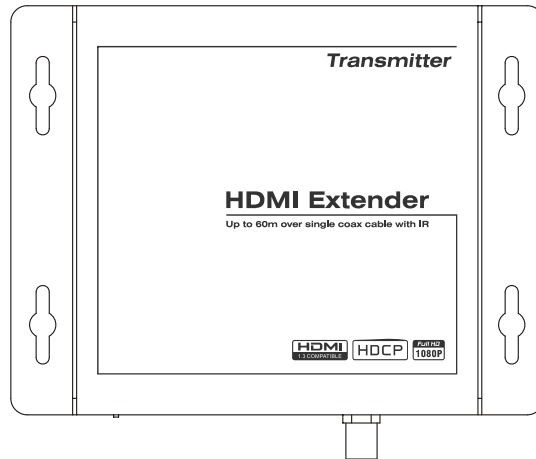

2. EX0101-S22

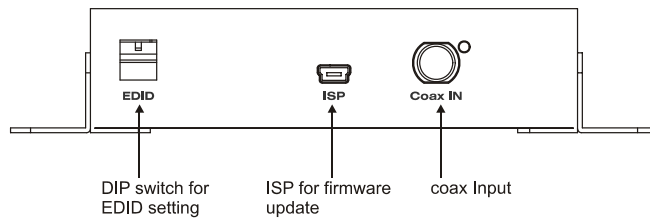
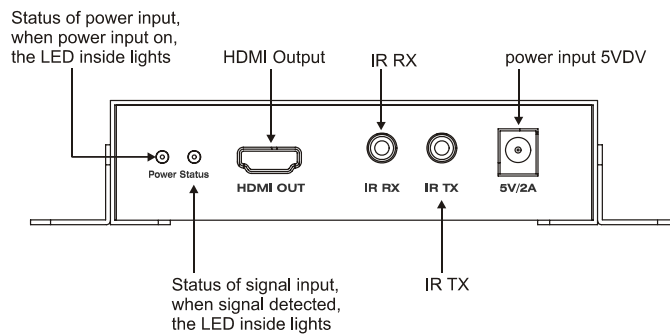
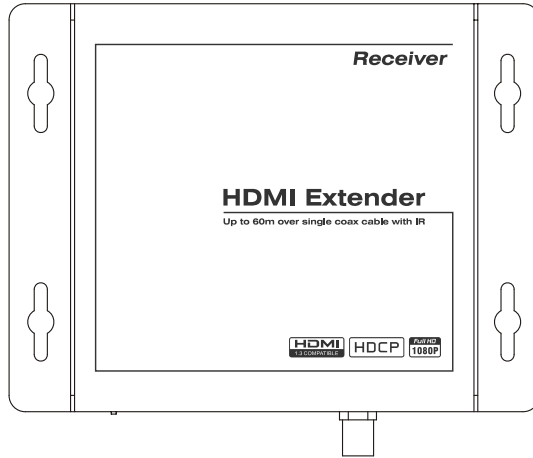

■ Typical Application

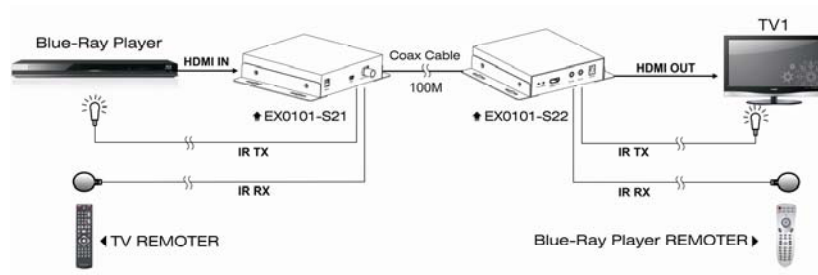

■ Maintenance

Clean this unit with a soft, dry cloth. Never use alcohol, paint thinner or benzine to clean this unit.

■ Product Service

● Provided Service

- 1) **Damage Requiring service:** The unit should be serviced by qualified service personnel if:
 - The DC power supply cord or AC adaptor has been damaged;
 - Objects or liquids have gotten into the unit;
 - The unit has been exposed to rain;
 - The unit does not operate normally or exhibits a marked change in performance;
 - The unit has been dropped or the cabinet damaged.
- 2) **Servicing Personnel:** Do not attempt to service the unit beyond that described in these operating instructions. Refer all other servicing to authorized servicing personnel.

- 3) **Replacement parts:** When parts need replacing ensure the service uses parts specified by the manufacturer or parts that have the same characteristics as the original parts. Unauthorized substitutes may result in fire, electric shock, or other hazards.
- 4) **Safety check:** After repairs or service, ask the service to perform safety checks to confirm that the unit is in proper working condition.

● **Mail-In Service**

When shipping the unit, carefully pack and send it prepaid, adequately insured and preferably in the original carton. Include a letter detailing the complaint and provide a daytime phone and/or email address where you can be reached.

If repair is needed during the limited warranty period the purchaser will be required to furnish a sales receipt/proof of purchase indicating date of purchase, amount paid and place of purchase. Customer will be charged for the repair of any unit received without such proof of purchase.

● **Warranty**

If your product does not work properly because of a defect in materials or workmanship, Grandbeing Company (referred to as “the warrantor”) will, for the length of the period indicated as below, (**Parts (1) Year, Labor(90) Days**) which starts with the date of original purchase (“Limited Warranty period”), at its option either (a) repair your product with new or refurbished parts, or (b) replace it with a new or a refurbished product. The decision to repair or replace will be made by the warrantor.

During the “Labor” Limited Warranty period there will be no charge for labor. During the “Parts” warranty period, there will be no charge for parts. You must mail-in your product during the warranty period. This Limited Warranty is extended only to the original purchaser and only covers product purchased as new. A purchase receipt or other proof of original purchase date is required for

Limited Warranty service.

● **Warranty Limits And Exclusions**

- 1) **This Limited Warranty ONLY COVERS failures due to defects in materials or workmanship, and DOES NOT COVER normal wear and tear or cosmetic damage.** The Limited Warranty ALSO DOES NOT COVER damages which occurred in shipment, or failures which are caused by products not supplied by the warrantor, or failures which result from accidents, misuse, abuse, neglect, mishandling, misapplication, alteration, faulty installation, set-up adjustments, misadjustment of consumer controls, improper maintenance, power line surge, lightning damage, modification, or service by anyone other than a Factory Service Center or other Authorized Service, or damage that is attributable to acts of God.
- 2) **There are no express warranties except as listed under “limited warranty coverage”. The warrantor is not liable for incidental or consequential damages resulting from the use of this product, or arising out of any breach of this warranty.** (As examples, this excludes damages for lost time, cost of having someone remove or re-install an installed unit if applicable, travel to and from the service location, loss of or damage to media or images, data or other recorded content. The items listed are not exclusive, but are for illustration only.)
- 3) **Parts and service, which are not covered by this limited warranty, are your responsibility.**



Grandbeing Technology Co., Ltd.

Address:

6C, Jialitai Building, No. 6 Yanshan Road,
Nanshan District Shenzhen, P.R. China

Tel: 86-755-26678449/Fax: 86-755-26678549
Post Code: 518067

www.grandbeing.biz